



圣阳电源 山东圣阳电源股份有限公司  
SACRED SUN SHANDONG SACRED SUN POWER SOURCES CO.,LTD

Documentation NO: TC-UM01-01

Version NO: A/0

Page: 1 Of 15

Telecom Backup Wall-mounted Lithium Battery Module

# Product Manual

(For Reference Only)

Tel: +86-537-4438666extn6068

Fax: +86-537-4438666extn6112

Address: No. 1 Shengyang Road, Qufu City, Shandong Province, China

Website: <http://www.sacredsun.com.cn>



# Contents

- I, Security Precautions
- II, Product Characteristics
- III, System Working Principle
- IV, Products Specifications
- V, Lithium System Components
- VI, Installation and Operation Instruction
- VII, Security Notices









# Security Precautions:

Honorific Clients:

Thank you so much for using Lithium battery from Shandong Sacred Sun Power Sources CO.,Ltd. Please read these instructions carefully in order to make correct, safe and effective operation. This manual provides you with very important installation and operation guidelines, which will guarantee your equipment an optimal performance.

Please follow the prompt seriously:

- For your safety and avoiding damage to battery, please do not open and tear down battery module.
- During battery movement, storage, maintenance, use and scrapping, it should be handled with care. Impact, knock and stab are prohibited.
- The storage of Lithium battery module should be far away from fire, heating sources and it is prohibited to put in flammable and explosive environment with inflammable gas and so on.
- Only professionals shall be allowed to operate battery maintenance.
- Only professionals ,with experiences and knowing much of battery potential danger and preventive action, shall be allowed to operate battery replacement.
- Please choose the replacement batteries of the same model from the same manufacturer with the same products.
- Please the following notes during using process:

				
Warning	Electricity shock	Protecting eyes	No short circuit	With adults custody
				

Read instructions	No flame and spark	Recycled	Proper disposal	Anti-static
-------------------	--------------------	----------	-----------------	-------------

## Product Characteristics:

- Battery positive plate is made of LiFePO4 materials, with high heating stability, good safety performance, and in long service life.
- All the electrical core have core-control, produced under strict controlled environment, to ensure temperature, humidity and cleanness requirement of battery, to reduce possibility of battery discharging and short circuit.
- All the electrical core should be strictly screened and classified about performance, adopted unique matched technical, to ensure the balanced consistency of cell electrical performance in battery banks.
- Adopted high performance BMS battery management module which is produced by dedicated programmable battery management chip, it has protective function, like over-discharging, over-charging, over-current and temperature.
- Scientifically reasonable control panel layout, with unique display of functions.
- Lithium module has RS232 telecom interface, which is used to effectively output the module system working conditions, warning status, etc.
- Lithium module has display screens, through which the real-time battery working voltage, working current, cell voltage, environment temperature, and battery temperature warning information can be checked.
- Lithium module has automatic hibernate function, which is in hibernate automatically after 10 hours in standby and it is needed to start manually.

## System working principle:

Telecom Lithium battery system working principle, showed as picture 1



图 1: Telecom Lithium battery system working principle

Telecom Lithium battery system, integration standby power sources system working principle: to input 220V electric supply, system provides needed power for load meanwhile charge Lithium battery built-in system when the grid is normal. When the grid is turned off, Lithium battery banks built-in system provides needed power for load, to ensure DC power sources system normal and keep uninterrupted power supply function. The system has the function of power down for second time, when battery voltage is over low, power sources cuts off the battery power supply to protect battery service life.

## Products Specifications:

Form 1: Telecom Lithium battery system specifications

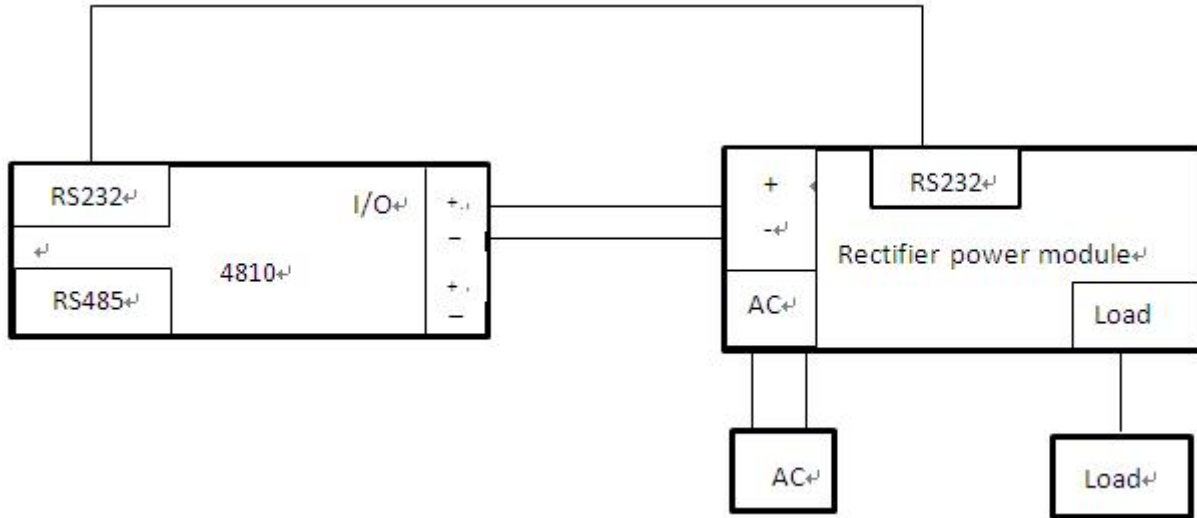
Table 1: Telecom Lithium battery system specifications

System type	48V10Ah	48V20Ah	48V30Ah	48V40Ah	48V50Ah
Nominal voltage [V]	48	48	48	48	48
Nominal capacity [C][Ah]	10	20	30	40	50

Capacity [C][Wh]	500	1000	1500	2000	2500
Length [mm]	442	442	442	442	442
Width [mm]	240	240	240	300	300
Height [mm]	44[1U]	88[2U]	132[3U]	177[4U]	177[4U]
Weight [kg]	About 7.9	About 13.0	About 18.0	About 24.0	About 28.0
Working voltage [V]	40.5-57.0	40.5-57.0	40.5-57.0	40.5-57.0	40.5-57.0
Charging limited voltage [V]	54.6	54.6	54.6	54.6	54.6
Maximum continued discharging current[A]	20	40	50	50	50
Charging time [h]	≤ 10	≤ 10	≤ 10	≤ 10	≤ 10
Cycle life 25°C	≥2000				

**System protection function and specifications:**

Current, voltage, temperature, etc values, measured by system, are used as basic data, which are used for protection function of system. After warning or protection, the relevant action and LED lights will direct. The protection function and data are showed in Form 2.

Table 2, Protection function and data



Protection function	Protection data values		Parameter value	Notes
	Cell	48V system		
Over-voltage protection	3.85±0.025V	\	3.45±0.025V	Lower than recovery value of over-charging protection
Operating environment temperature	-20 °C , 65°C		/	/
Charging over-current protection	≥20A	≥20A	Rescind the exceed current 32s, then released	/
Low voltage warning	2.7V	\	\	The alarms valid if the cell voltage lower than the protection value
Power down for the first time	2.7V	\	Release when charging	Release when charging
Power down for the second time	2 3V	\	Release when charging	the cell voltage lower than the protection value
Discharging over-current protection	48V10Ah	≥12A	Rescind the exceed current 32s, then released	/
	48V20Ah	≥28A		
	48V30Ah	≥38A		
	48V40Ah	≥48A		
	48V50Ah	≥56A		

Over-temperature protection	$\geq 70^{\circ}\text{C}$	$55 \pm 3^{\circ}\text{C}$	Cut off when over $70^{\circ}\text{C}$
Short circuit protection	$80 \pm 20\text{A}$	Cut off load	/

## Lithium Module System Components :

Graph2: LiFeP04 module system panel

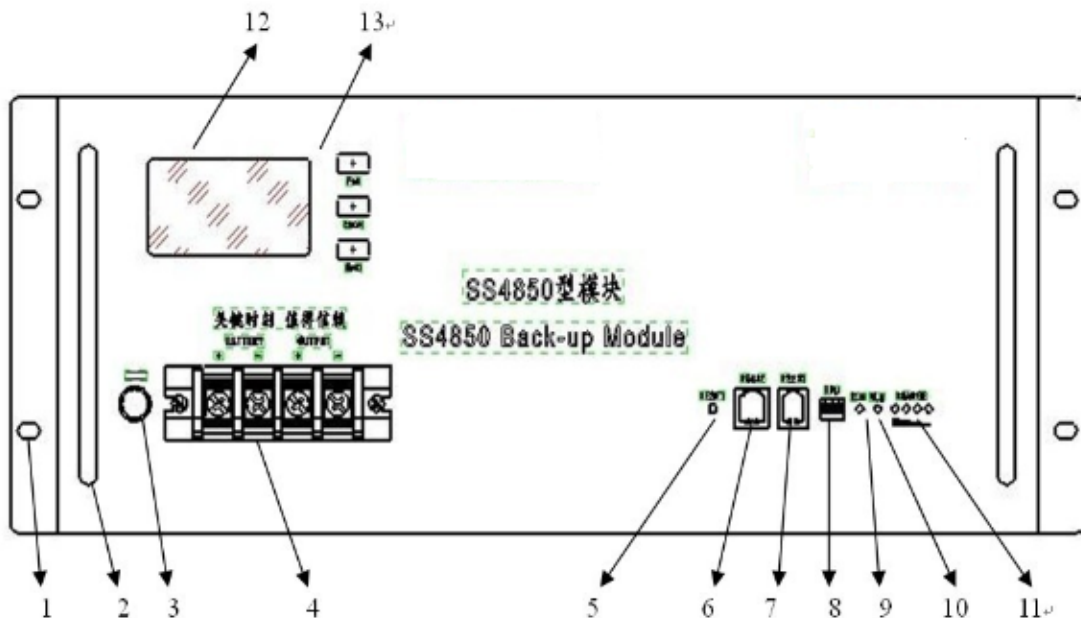

1. lashing eye: Use the Nut and Screw to fix;
2. Handle: Easily for the battery movement;
3. Fuse: Protect the equipment from the exceed current, avoid the serious trouble because of the internal failure;
4. Output Lug of battery: The produce use 4core End Lug, mainly used in connect the battery module, the 2 lead pin of end lug obeys from left to right, defined as battery positive polarity and negative polarity(Indicates the “+” and “-” outside).
5. “RESET” key: When suffers the abnormity, can use this key to reposition the system, Ensures the stability of the system. This key can also be used for closing or starting.



6. RS485 telecom interface: When connected the system, the data transfers in RS485 Serial telecom. Table3 indicated the definition of the RS485 interface. Cascaded Pack system use the RS485 telecom internally, the upper system acquires every Slave Pack data all via the Master Pack.

7. RS232 Telecom Interface: The upload data of battery system use RS232 Serial telecoms style. Table 3 is the definition of the RS232 interface. The data transfer includes: system parameter, system status and alarming information. RS232 telecom commonly use the 1200bps speed. Only the switch set to Pack1 (Master Pack), the RS232 module can be valid, can only communicated with the upper machine.

Table3 The definition of RS485 and RS232 interface

Telecom Interface	Lead Pin	Definition Remarks
RS485	1、 8	RS485-A
	2、 7	RS485-B
	3、 6	Floor
	4、 5	NC (hang in the ar)
RS232	1	Floor
	2	Single plate receive, The computer sends
	3	Single plate receive, The computer sends
	4	floor

8. wave band switch. There is one switch on the plate, used for setting the address code in the communication, , Table 4 is the setting of the address code.

Table 4 The setting of the wave band address code

Wave Band				addresses	Pack define	Remark
ON	OFF	OFF	OFF	1	Pack1	As Master Pack, allow RS232 telecom
OFF	ON	OFF	ON	2	Pack2	As Slave Pack1
ON	ON	ON	OFF	3	Pack3	As Slave Pack2
OFF	OFF	ON	ON	4	Pack4	As Slave Pack3

ON	ON	ON	OFF	5	Pack5	As Slave Pack4
----	----	----	-----	---	-------	----------------

9. The lighting “RUN” : indicated the running status of battery group, Table5 is the remarks of the LED light.

10. Alarming LED light “ALM” : Indicates the alarming, Table 5 is the remarks of LED lighting.

11. The capacity of battery’ s the LED lighting: indicates the capacity of Lithium battery, Table 5 is the remarks of LED lighting.

Table 5 the remarks of LED lighting

PACK status	Protection /Warning/Normal	RUN	ALM	LED green				Notes
		●	●	●	●	●	●	
Power off		Off	Off	Off	Off	Off	Off	All off
Standby	Normal	Flash	Off	Off	Off	Off	Off	Standby condition
	Warning	Off	Flash	Off	Off	Off	Off	twinkling, PACK low voltage
Charging	Normal	Long on	Off	Indicates by the capacity				The max capacity LED twinkling, others bright
	Warning	Long on	Flash					
	Protection	Flash	Off	Off	Off	Off	Off	Stop charging
Discharging	Normal	Flash	Off	Indicates by the capacity				Indicates by the capacity
	Warning	Flash	Flash					
	Protection	Off	Long on	Off	Off	Off	Off	Stop discharge, ALM LED bright

12.LCD: indicates the total voltage, cell voltage, module temperature, current, capacity, SOC etc.。

13.Display Screen: Display Screen function key, Fun: Next Screen; Next: Display the

cell voltage; Ent: Display the screen' s brightness.

\*Indicates LED: RUN: Green, ALM: Red; LED twinkling: twinkling\_on 0.5s, off 3s.

Indicates LED of battery capacity: Four green indicates 25% of capacity. if 100%, 4 lights all on; if 75%, the left one off, the right three all on; if 50%, the left two lights off, the right two lights on; if 25%, the left three lights off, the right one is on.

## Installation and Operation Instruction:

Please carefully read the following manual before using, the detailed using methods:

- Before using, please take on the Lithium module, check the lights of run status and capacity on or not.
- Please check the equipment' s model, especially the rated power, rated voltage, rated current (My company' s Lithium module marked voltage is 48V) , avoid the equipment' s broken.
- Before installation, Please make sure the floating voltage 53.5-54.6V and average voltage value 53.5-54.6V, charging current  $\leq 20A$ .
- Before connect the lines, please cut off the power first.
- When connected the lines, please check the line if it is good, one red line is used to connected the “+” pole, and one black line is used to connect the “-” pole. As the following graph indicates:

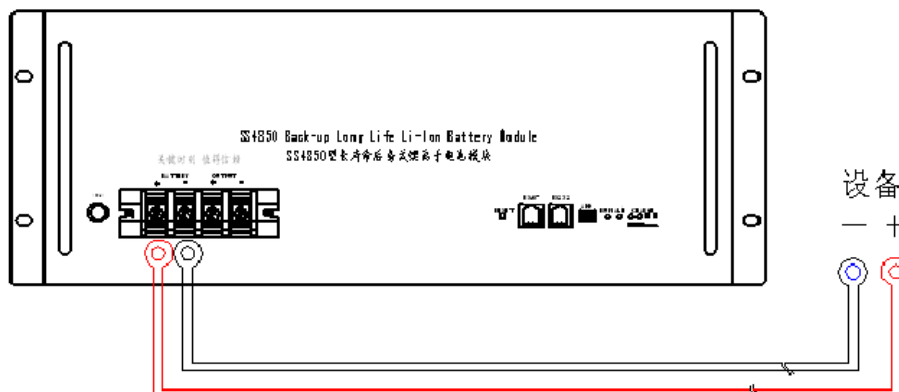

Graph 3

● After the installation, connect the line between the equipment and the battery module, when the LED indicates the status “RUN” .

The indicating light of battery capacity is shining, it means the battery module and the equipment is working well. In the event of over-current, over-voltage and under-charging, etc. For self protection, the battery will turn from outputting to emergency. At this circumstance, the status “RUN” and capacity indicating light will be off , and emergency light will be on . At this time , when it back to the normal instance about 10s, the Lithium module will Back to normal and release from alarm state.

● installation procedure:

(1) Use M4\*8 fixation nail to fix the two boards and base salver.



(2) Fix the hanging frame in the wall (using swelling snail) .Be sure that the handing frame is parallel straight with the wall. There should be no leaning of hanging frame, and no shaking. Fix the four fixing snail in the hole inside.



(3) Ground wire should be connected to the bottom of the battery. (There's ground wire notice.)



(4) Put the batteries in the hanging frame and fix them with fixation snail.

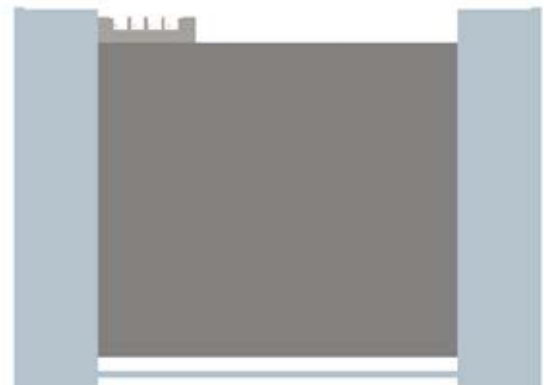

(5) The red power line and the black power line should be respectively connected to the positive and negative barrier ends. And should be leaning by power line from the side board of the barrier.



(6) Connect the ground line to the ground ejection, and connect the power line to the switching power. Ensure that the equipment is running efficiently.

(7) Open the mains supply and check if the batteries could charge.

(8) Cut off the mains supply and check if the batteries could discharge.

(9) Put the upper cover of hanging frame to it, and tighten it with M3 fixation snail.

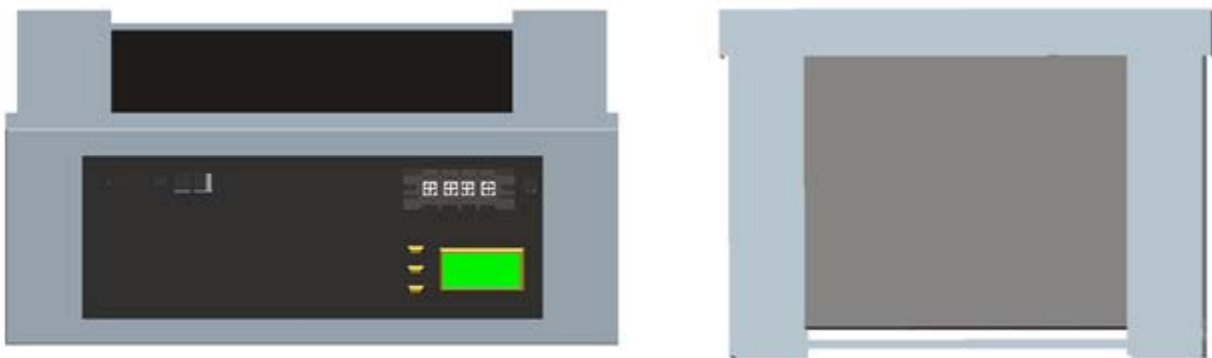

## Security Notices:

- Before using, please check whether the function switches of Lithium module and panel are good or nor, and whether the buttons are flexible or not.
- Please move and place battery lightly and do not impact the battery when using the Lithium module.
- For the security of Lithium module, please check again the equipment of charging is in the scope of using requirement.

- Should avoid straight sun and don't put in the damp and hot place and avoid water leaking.
- When the Lithium module is working, it should be airy; do not let it near any other heating sources.

**Statement: Because of updated and improvement of our products and technology, the content of this materials will not be exactly the same as real products, please kindly note and understand that. If you want to know more updated information, please contact with us.**